



## DIMENSIONS

MILLIMETERS(INCHES)

### CVR SERIES RELIEF VALVES - VENTED (Screw - in Cartridge Valves)

#### Ordering Code

**CVR - 063 - K - 10 N**

Seals: N-Buna N  
V-Viton

Adjustment Ranges  
10 - 5 to 100bar  
20 - 7 to 210bar  
30 - 10 to 315bar  
1S - 3.5 to 100bar (option)  
2S - 5 to 210bar (option)

Controls: K-Handknob  
L-Leakproof

Cavity Size

Series No. Ventable Relief Valves

#### Cartridge Valve Specifications

Flow rating	50 lpm (13 gpm)
Max. Pressure	315 bar (4500 psi)
Weight of Cartridge	K: 0.17 kg (L: 0.14 kg)
Cavity No.	C - 063 (See Cavity Details section)
Cavity Tools	CT36-D, CT36-R
Mounting	No Restrictions
Description	Vented Spool, Pilot Operated

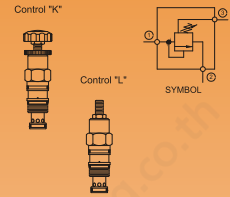

Flow-Pres. Drop Curve

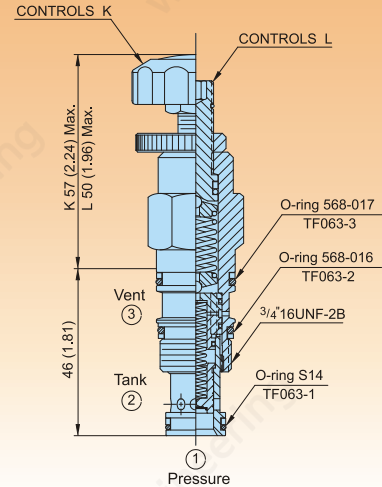
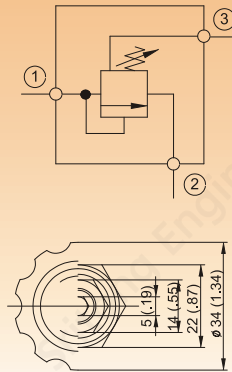
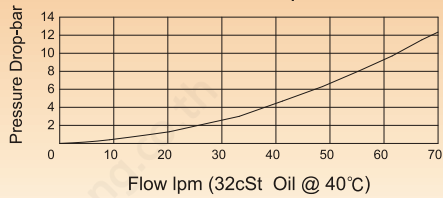

### CSV SERIES-SEQUENCE VALVES (Screw - in Cartridge Valves)

#### Ordering Code

**CSV - 063 - K - 20 N**

Seals: N-Buna N  
V-Viton

Adjustment Ranges  
10 - 5 to 100bar  
20 - 7 to 210bar

Controls: K-Handknob  
L-Leakproof

Cavity Size

Series No. Sequence Valves

#### Cartridge Valve Specifications

Flow rating	60 lpm (16 gpm)
Max. Pressure	315 bar (4500 psi)
Weight of Cartridge	K: 0.17 kg (L: 0.14 kg)
Cavity No.	C - 063 (See Cavity Details section)
Cavity Tools	CT36-D, CT36-R
Mounting	No Restrictions
Description	Pilot Operated, Blanced Spool

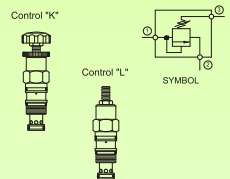

Flow-Pres. Drop Curve

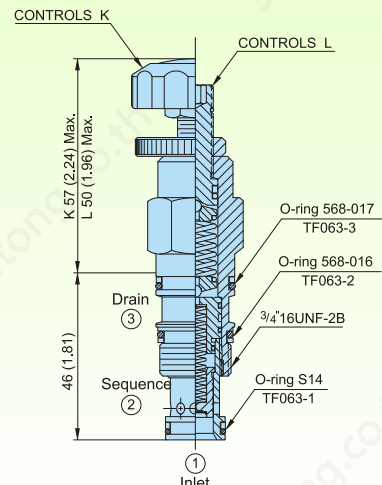
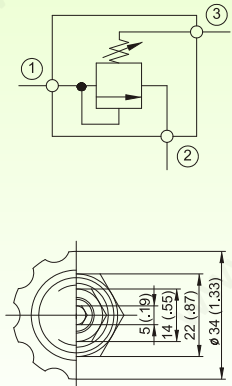
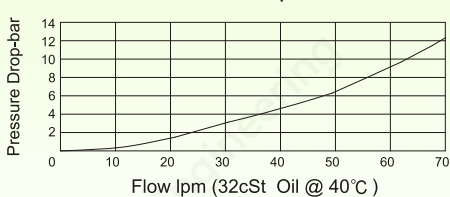

## DIMENSIONS

MILLIMETERS(INCHES)

### CS1 SERIES SEQUENCE VALVES - EXTERNAL PILOT OPERATED

(Screw - in Cartridge Valves)

#### Ordering Code

**CS1 - 063 - K - 10 N**

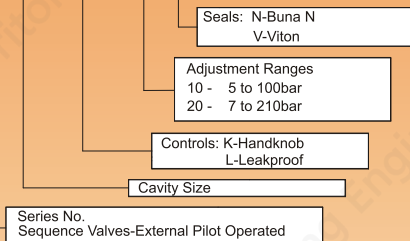

#### Cartridge Valve Specifications

Flow rating	12 lpm (3 gpm)
Max. Pressure	315 bar (4500 psi)
Weight of Cartridge	K: 0.17 kg (L: 0.14 kg)
Cavity No.	C - 063 (See Cavity Details section)
Cavity Tools	CT36-D, CT36-R
Mounting	No Restrictions
Description: External Pilot Operated, Blanced Spool	

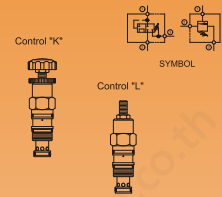

Flow-Pres. Drop Curve

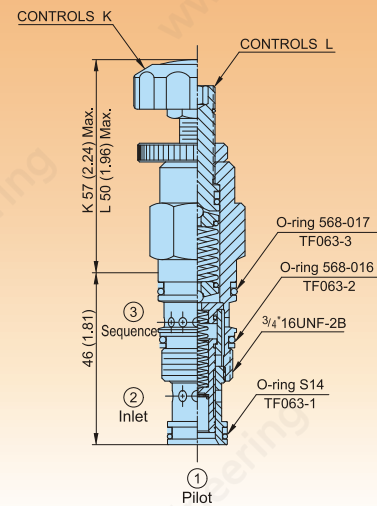
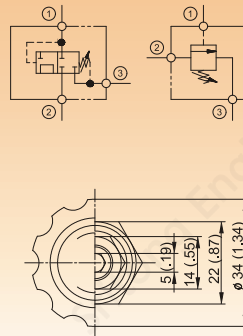
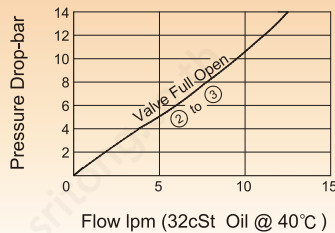

### CRD SERIES-REDUCING VALVES

(Screw - in Cartridge Valves)

#### Ordering Code

**CRD - 063 - K - 10 N**

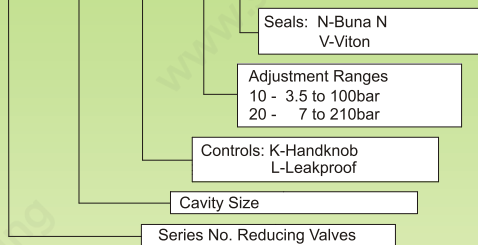

#### Cartridge Valve Specifications

Flow rating	30 lpm (8 gpm)
Max. Pressure	315 bar (4500 psi)
Weight of Cartridge	K: 0.17 kg (L: 0.14 kg)
Cavity No.	C - 063 (See Cavity Details section)
Cavity Tools	CT36-D, CT36-R
Mounting	No Restrictions
Description: Pilot Operated, Blanced Spool	

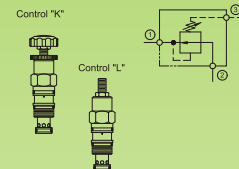

Flow-Pres. Drop Curve

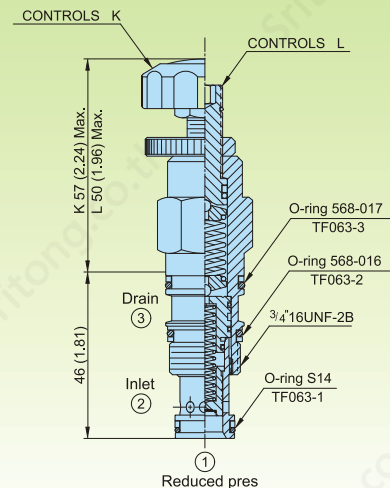
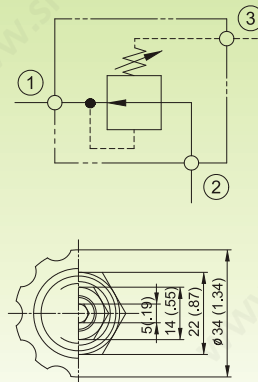
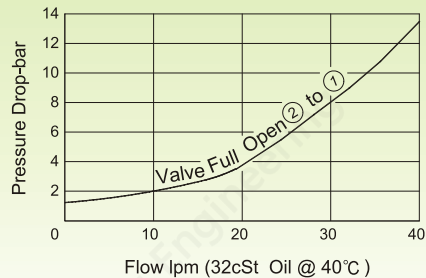



# CARTRIDGE VALVES

## DIMENSIONS

MILLIMETERS(INCHES)

### CRR SERIES REDUCING / RELIEF VALVES

(Screw - in Cartridge Valves)

#### Ordering Code

**CRR - 063 - K - 10 N**

Seals: N-Buna N  
V-Viton

Adjustment Ranges  
10 - 5 to 100bar  
20 - 7 to 210bar

Controls: K-Handknob  
L-Leakproof

Cavity Size

Series No.  
Reducing / Relieving Valves

#### Cartridge Valve Specifications

Flow rating	30 lpm (8 gpm)
Max. Pressure	315 bar (4500 psi)
Weight of Cartridge	K: 0.17 kg (L: 0.14 kg)
Cavity No.	C - 063 (See Cavity Details section)
Cavity Tools	CT36-D, CT36-R
Mounting	No Restrictions
Description	Pilot Operated, Blanced Spool

Control "K"

Control "L"



#### Flow-Pres. Drop Curve

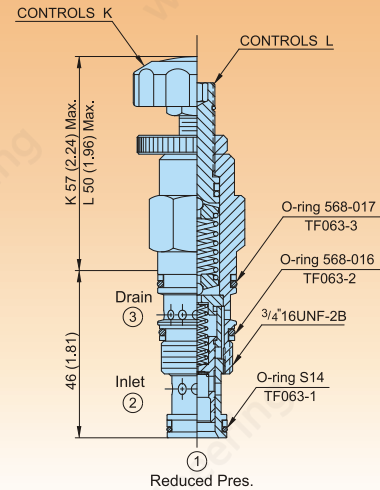
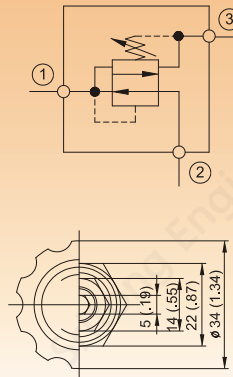
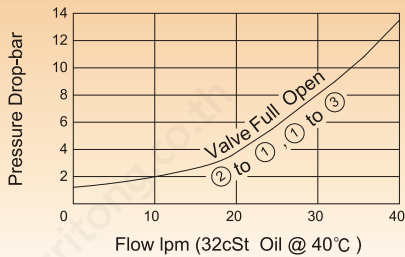

### CMD SERIES RELIEF VALVES

(Screw - in Cartridge Valves)

#### Ordering Code

**CMD - 082 - K - 03 N**

Seals: N-Buna N  
V-Viton

Adjustment Ranges  
03 - 2 to 30 bar  
10 - 3 to 100 bar  
20 - 10 to 210 bar  
30 - 20 to 315 bar

Controls:  
K - Handknob ( dia.30 )  
KW - Handknob ( dia.38 )

Cavity Size

Series No. Remote Control Relief Valves

#### Cartridge Valve Specifications

Flow rating	2 lpm (0.5 gpm)
Max. Pressure	315 bar (4500 psi)
Weight of Cartridge	KW: 0.21 kg ( K: 0.13 kg )
Cavity No.	C - 082 (See Cavity Details section)
Cavity Tools	CT28-D, CT28-R
Mounting	No Restrictions
Description	Poppet, Direct Acting

Control "K"

Control "KW"

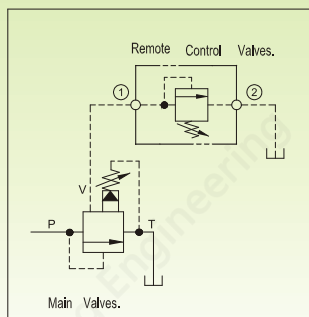

DETAILED SYMBOL

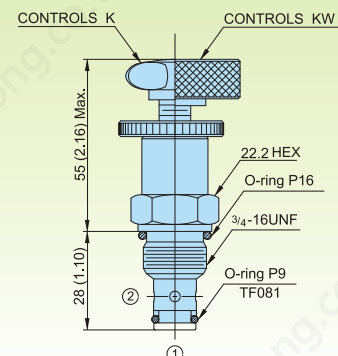
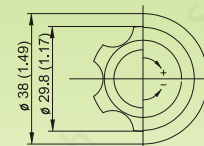
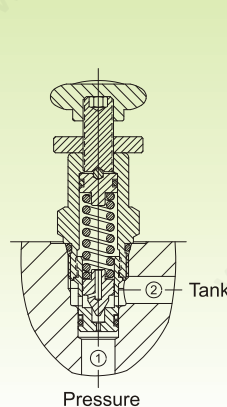

## DIMENSIONS

MILLIMETERS(INCHES)

### CMD SERIES-RELIEF VALVES

(Screw - in Cartridge Valves)

#### Ordering Code

**CMD - 082 - PK - 10 N**

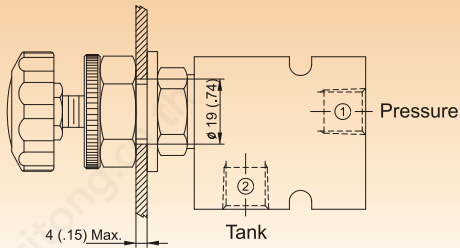
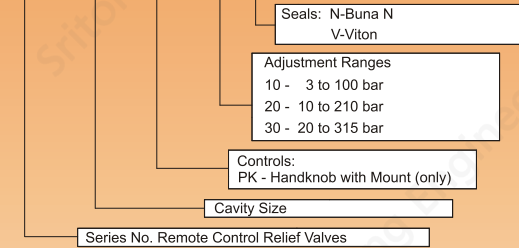

#### Cartridge Valve Specifications

Flow rating	2 lpm (0.5 gpm)
Max. Pressure	315 bar (4500 psi)
Weight of Cartridge	PK: 0.19 kg
Cavity No.	C - 082 (See Cavity Details section)
Cavity Tools	CT28-D, CT28-R
Mounting	No Restrictions
Description:	Poppet, Direct Acting with Panel Mount

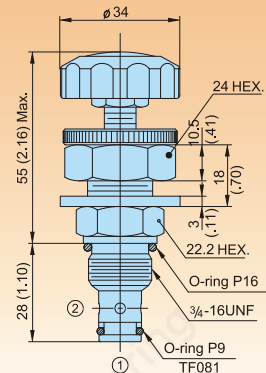
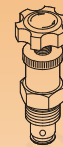
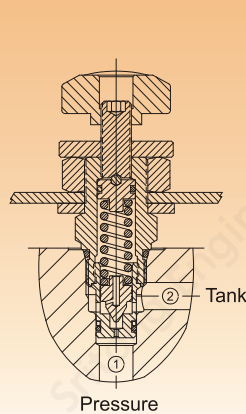
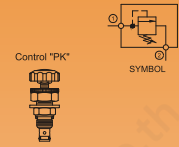

### CMR SERIES-RELIEF VALVES

(Screw - in Cartridge Valves)

#### Ordering Code

**CMR - 082 - K - 10 N**

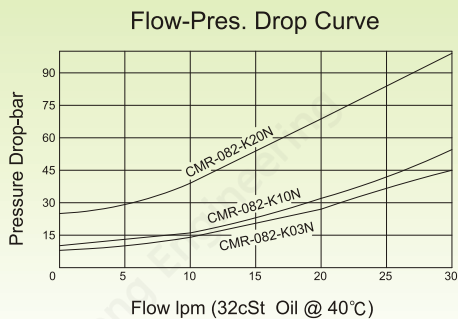
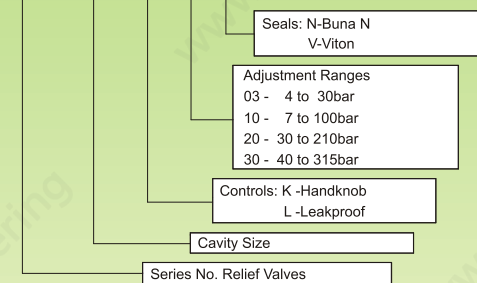

#### Cartridge Valve Specifications

Flow rating	20 lpm (5 gpm)
Max. Pressure	315 bar (4500 psi)
Weight of Cartridge	K: 0.13 kg (L: 0.10 kg)
Cavity No.	C - 082 (See Cavity Details section)
Cavity Tools	CT28 - D, CT28 - R
Mounting	No Restrictions
Description:	Poppet, Direct Acting

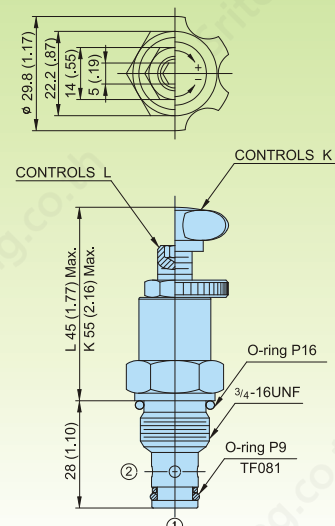
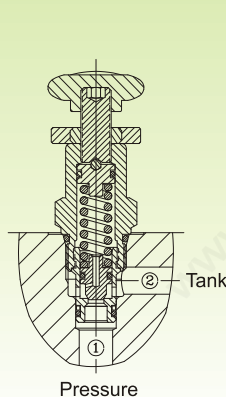
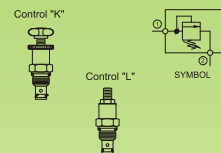



## DIMENSIONS

MILLIMETERS(INCHES)

### CMR SERIES-RELIEF VALVES

(Screw - in Cartridge Valves)

#### Ordering Code

**CMR - 092 - J - 40 N**

Seals: N-Buna N  
V- Viton

Adjustment Ranges  
10 - 5 to 100bar  
20 - 70 to 210bar  
40 - 110 to 400bar

Controls: J- Capped Adjustment  
(Only)

Cavity Size

Series No. Relief Valves

#### Cartridge Valve Specifications

Flow rating	50 lpm (13 gpm)
Max. Pressure	400 bar (5500 psi)
Weight of Cartridge	K: 0.16 kg
Cavity No.	C - 092 (See Cavity Details section)
Cavity Tools	CT29-D, CT29-R
Mounting	No Restrictions
Description	Direct Acting, Differential Area

Control "J"



SYMBOL

#### Flow-Pres. Drop Curve

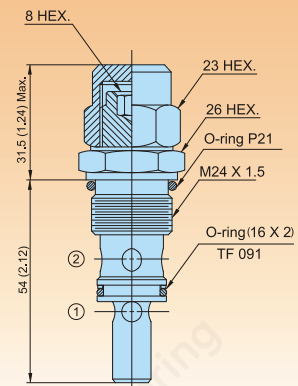
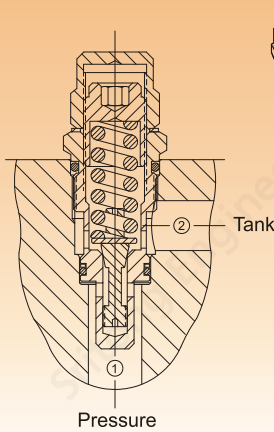
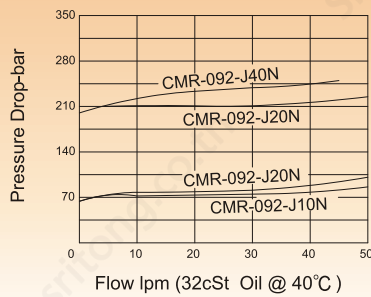

### CMR SERIES-RELIEF VALVES

(Screw - in Cartridge Valves)

#### Ordering Code

**CMR - 092 - KW - 20 N**

Seals: N-Buna N  
V- Viton

Adjustment Ranges  
10 - 5 to 100bar  
20 - 70 to 210bar

Controls:  
KW - Capped Adjustment (only)

Cavity Size

Series No. Relief Valves

#### Cartridge Valve Specifications

Flow rating	50 lpm (13 gpm)
Max. Pressure	210 bar (3000 psi)
Weight of Cartridge	KW: 0.31 kg
Cavity No.	C - 092 (See Cavity Details section)
Cavity Tools	CT29 - D, CT29 - R
Mounting	No Restrictions
Description	Direct Acting, Differential Area

Control "KW"



SYMBOL

#### Flow-Pres. Drop Curve

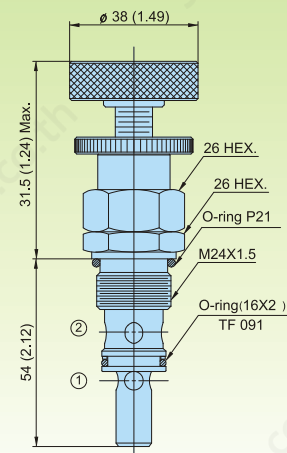
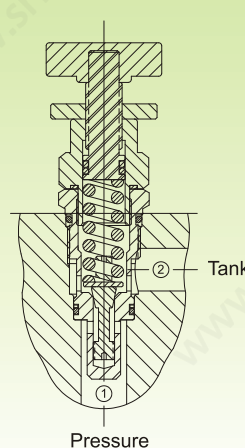
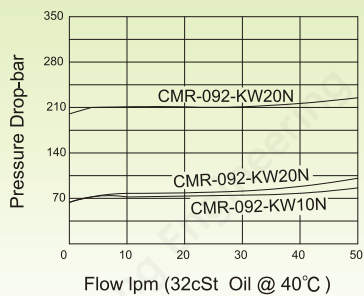

## DIMENSIONS

MILLIMETERS(INCHES)

### CRV SERIES-RELIEF VALVES

(Screw - in Cartridge Valves)

#### Ordering Code

**CRV - 092 - K - 10 N**

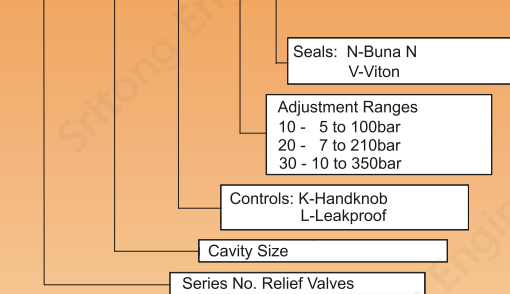

#### Cartridge Valve Specifications

Flow rating	100 lpm (26 gpm)
Max. Pressure	350 bar (5000 psi)
Weight of Cartridge	K: 0.19 kg (L: 0.15 kg)
Cavity No.	C - 092 (See Cavity Details section)
Cavity Tools	CT29-D, CT29-R
Mounting	No Restrictions
Description	Balanced Spool, Pilot Operated

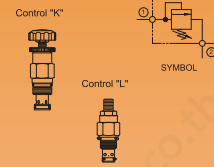

#### Flow-Pres. Drop Curve

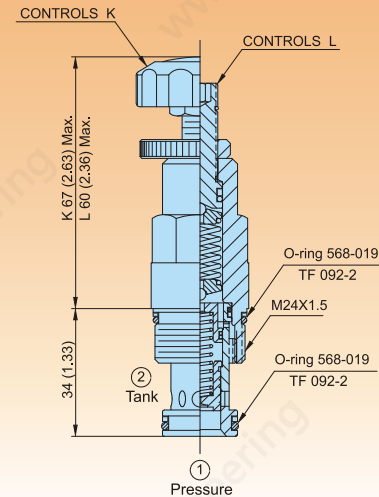
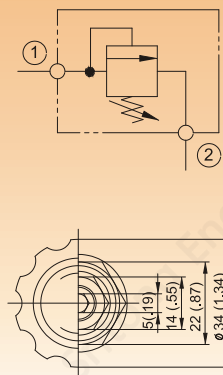
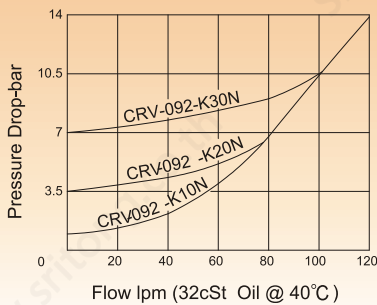

### CVR SERIES-RELIEF VALVES - VENTED

(Screw - in Cartridge Valves)

#### Ordering Code

**CVR - 093 - K - 10 N**

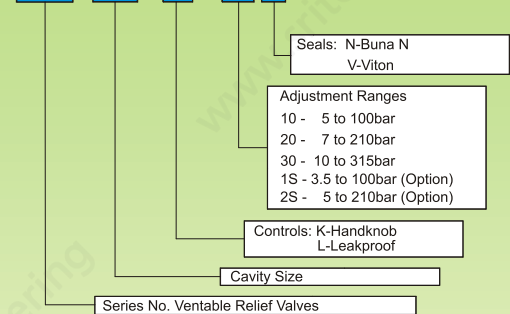

#### Cartridge Valve Specifications

Flow rating	90 lpm (24 gpm)
Max. Pressure	315 bar (4500 psi)
Weight of Cartridge	K: 0.29 kg (L: 0.25 kg)
Cavity No.	C - 093 (See Cavity Details section)
Cavity Tools	CT-39D, CT-39R
Mounting	No Restrictions
Description	Vented Spool, Pilot Operated

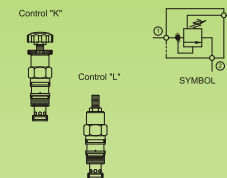

#### Flow-Pres. Drop Curve

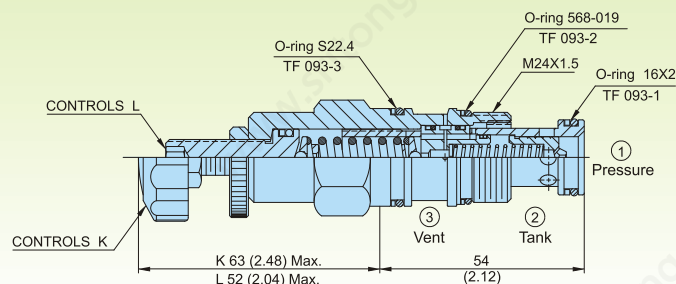
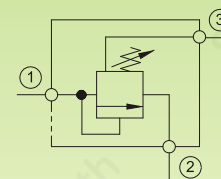
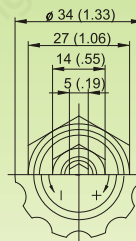
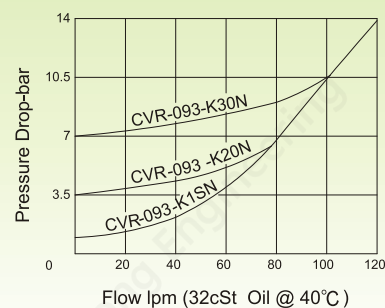



## DIMENSIONS

MILLIMETERS(INCHES)

### CSV SERIES-SEQUENCE VALVES

(Screw - in Cartridge Valves)

#### Ordering Code

**CSV - 093 - K - 20 N**

Seals: N-Buna N  
V-Viton

Adjustment Ranges  
10 - 5 to 100bar  
20 - 7 to 210bar

Controls: K-Handknob  
L-Leakproof

Cavity Size

Series No. Sequence Valves

#### Flow-Pres. Drop Curve

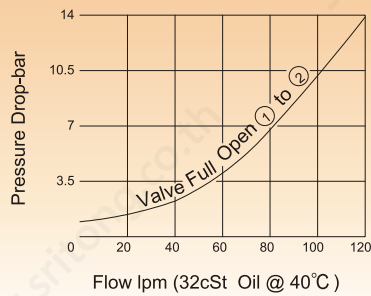

#### Cartridge Valve Specifications

Flow rating	100 lpm (26 gpm)
Max. Pressure	315 bar (4500 psi)
Weight of Cartridge	K: 0.29 kg (L: 0.25 kg)
Cavity No.	C - 093 (See Cavity Details section)
Cavity Tools	CT39-D, CT39-R
Mounting	No Restrictions
Description:	Pilot Operated, Blanced Spool

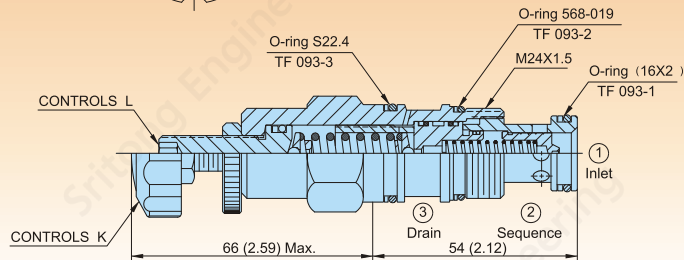
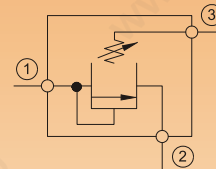
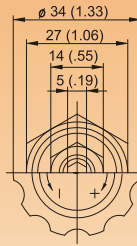
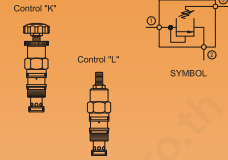

### CRD SERIES-REDUCING VALVES

(Screw - in Cartridge Valves)

#### Ordering Code

**CRD - 093 - K - 10 N**

Seals: N-Buna N  
V-Viton

Adjustment Ranges  
10 - 3.5 to 100bar  
20 - 7 to 210bar

Controls: K-Handknob  
L-Leakproof

Cavity Size

Series No. Reducing Valves

#### Flow-Pres. Drop Curve

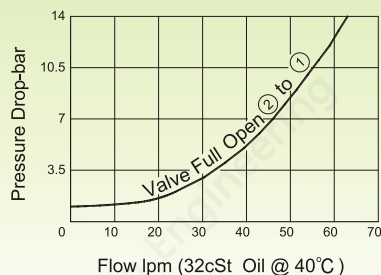

#### Cartridge Valve Specifications

Flow rating	50 lpm (13 gpm)
Max. Pressure	315 bar (4500 psi)
Weight of Cartridge	K: 0.29 kg (L: 0.25 kg)
Cavity No.	C - 093 (See Cavity Details section)
Cavity Tools	CT39-D, CT39-R
Mounting	No Restrictions
Description:	Pilot Operated, Blanced Spool

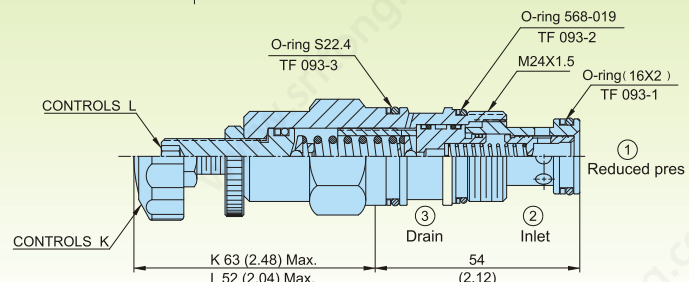
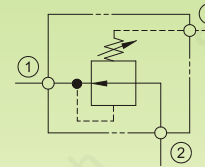
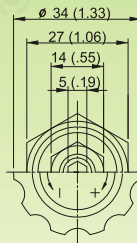
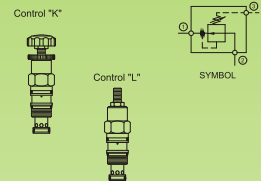

## DIMENSIONS

MILLIMETERS(INCHES)

### CRR SERIES-REDUCING / RELIEVING VALVES (Screw - in Cartridge Valves)

#### Ordering Code

**CRR - 093 - K - 10 N**

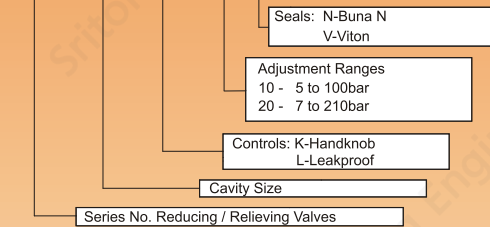

#### Cartridge Valve Specifications

Flow rating	50 lpm (13 gpm)
Max. Pressure	315 bar (4500 psi)
Weight of Cartridge	K: 0.29 kg (L: 0.25 kg)
Cavity No.	C - 093 (See Cavity Details section)
Cavity Tools	CT39-D, CT39-R
Mounting	No Restrictions
Description	Pilot Operated, Blanced Spool

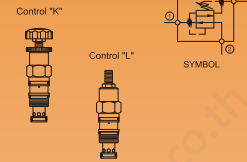

#### Flow-Pres. Drop Curve

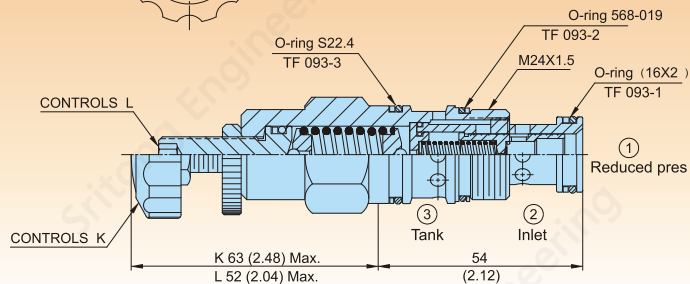
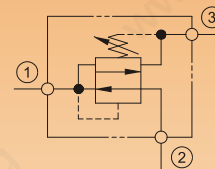
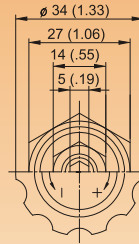
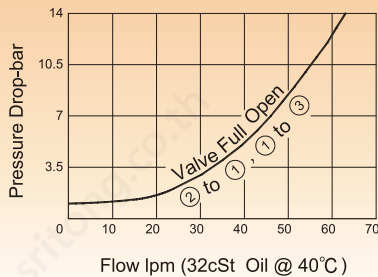

### CRV SERIES-RELIEF VALVES (Screw - in Cartridge Valves)

#### Ordering Code

**CRV - 102 - KS - 10 N**

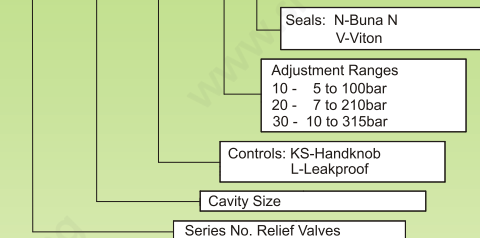

#### Cartridge Valve Specifications

Flow rating	60 lpm (16 gpm)
Max. Pressure	350 bar (5000 psi)
Weight of Cartridge	KS: 0.21 kg (L: 0.16 kg)
Cavity No.	C - 102 (See Cavity Details section)
Cavity Tools	CT20-D, CT20-R
Mounting	No Restrictions
Description	Balanced Spool, Pilot Operated

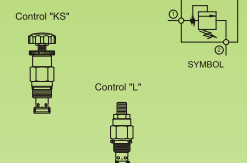

#### Flow-Pres. Drop Curve

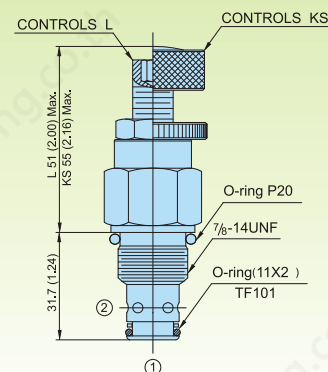
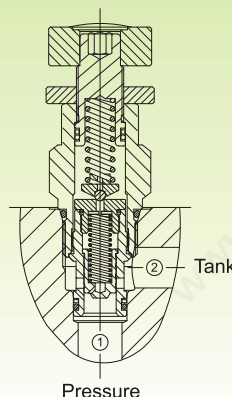
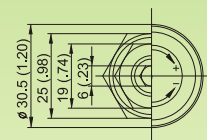
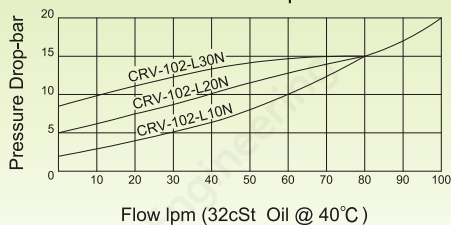



## DIMENSIONS

MILLIMETERS(INCHES)

### CCV SERIES COUNTERBALANCE VALVES (Screw - in Cartridge Valves)

#### Ordering Code

**CBC** - **063** - **L** - **2R** **N**

Seals: N-Buna N  
V-Viton

Adjustment Ranges  
2R - 20 to 150 bar  
3R - 30 to 280 bar  
\* R Cracking Pres. 2.0 bar  
2S - 20 to 150 bar  
3S - 30 to 280 bar  
\* S Cracking Pres. 0.2 bar

Controls:  
L - Leakproof

Cavity Size

Series No. Counterbalance Valves

#### Flow-Pres. Drop Curve

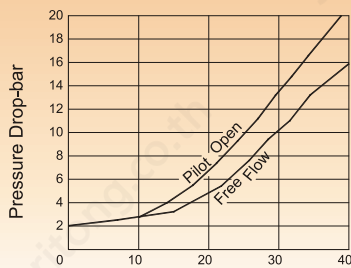

Flow lpm (32cSt Oil @ 40°C)

#### Cartridge Valve Specifications

Flow rating	30 lpm (8 gpm)
Max. Pressure	315 bar (4500 psi)
Weight of Cartridge	0.14 kg
Cavity No.	C - 063 (See Cavity Details section)
Cavity Tools	CT36-D, CT36-R
Mounting	No Restrictions
Description	Poppet Type, 3:1 Pilot Ratio

Control "L"



SYMBOL

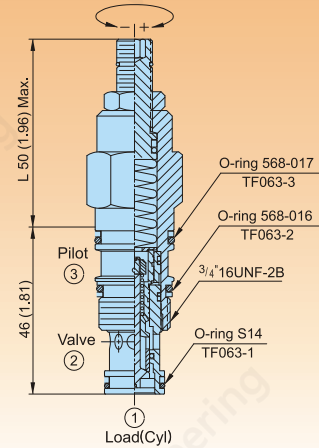
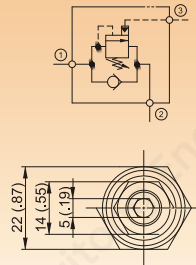

### CBF SERIES COUNTERBALANCE VALVES (Screw - in Cartridge Valves)

#### Ordering Code

**CBF** - **063** - **L** - **2R** **N**

Seals: N-Buna N  
V-Viton

Adjustment Ranges  
2R - 25 to 210 bar  
3R - 45 to 315 bar  
\* R Cracking Pres. 2.0 bar  
2S - 25 to 210 bar  
3S - 45 to 315 bar  
\* S Cracking Pres. 0.2 bar

Controls:  
L - Leakproof

Cavity Size

Series No. Counterbalance Valves

#### Flow-Pres. Drop Curve

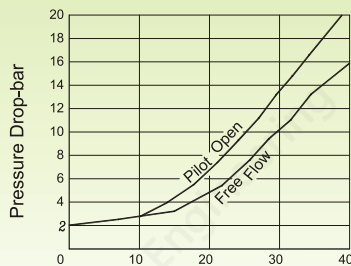

Flow lpm (32cSt Oil @ 40°C)

#### Cartridge Valve Specifications

Flow rating	30 lpm (8 gpm)
Max. Pressure	315 bar (4500 psi)
Weight of Cartridge	0.14 kg
Cavity No.	C - 063 (See Cavity Details section)
Cavity Tools	CT36-D, CT36-R
Mounting	No Restrictions
Description	Poppet Type, 4.5:1 Pilot Ratio

Control "L"



SYMBOL

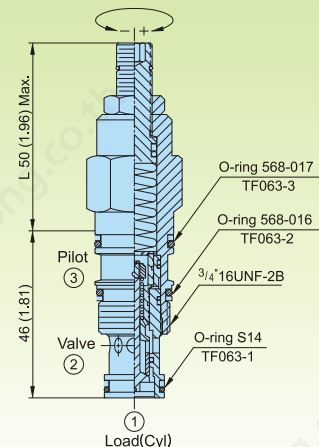
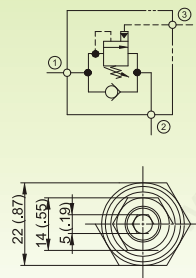

## DIMENSIONS

MILLIMETERS(INCHES)

### CBJ SERIES COUNTERBALANCE VALVES

(Screw - in Cartridge Valves)

#### Ordering Code

**CBJ - 063 - L - 3R N**

Seals: N-Buna N  
V-Viton

Adjustment Ranges  
3R - 45 to 315 bar  
4R - 70 to 470 bar  
\* R Cracking Pres. 2.0 bar  
3S - 45 to 315 bar  
4S - 70 to 470 bar  
\* S Cracking Pres. 0.2 bar

Controls:  
L - Leakproof

Cavity Size

Series No. Counterbalance Valves

#### Flow-Pres. Drop Curve

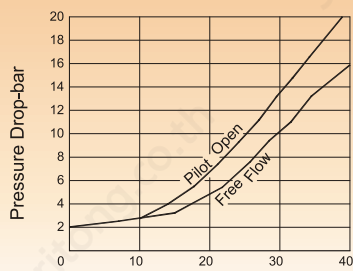

Flow lpm (32cSt Oil @ 40°C)

#### Cartridge Valve Specifications

Flow rating	30 lpm (8 gpm)
Max. Pressure	315 bar (4500 psi)
Weight of Cartridge	0.14 kg
Cavity No.	C - 063 (See Cavity Details section)
Cavity Tools	CT36-D, CT36-R
Mounting	No Restrictions
Description:	Poppet Type, 10:1 Pilot Ratio

Control "L"

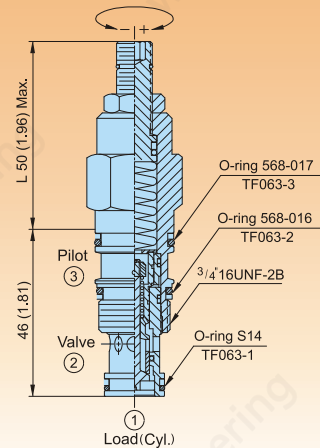
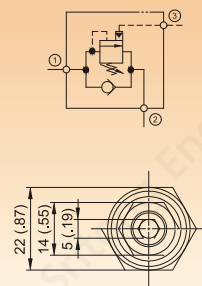

### CPF SERIES PILOT TO OPEN CHECK VALVES

(Screw - in Cartridge Valves)

#### Ordering Code

**CPF - 063 - X - 2.0 N**

Seals: N-Buna N  
V-Viton

Cracking Pressure  
0.2 - 0.2 bar  
2.0 - 2.5 bar

Pilot Port & Internal Seals  
X - Standard Type. No Pilot Piston Seal  
S - Standard Type. Seal on Pilot Piston

Cavity Size

Series No. Pilot to Open Check Valves

#### Flow-Pres. Drop Curve

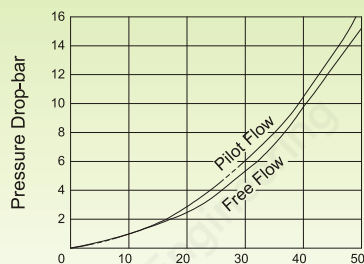

Flow lpm (32cSt Oil @ 40°C)

#### Cartridge Valve Specifications

Flow rating	30 lpm (8 gpm)
Max. Pressure	315 bar (4500 psi)
Weight of Cartridge	0.12 kg
Cavity No.	C - 063 (See Cavity Details section)
Cavity Tools	CT36-D, CT36-R
Mounting	No Restrictions
Description:	Poppet Type, 4.5:1 Pilot Ratio

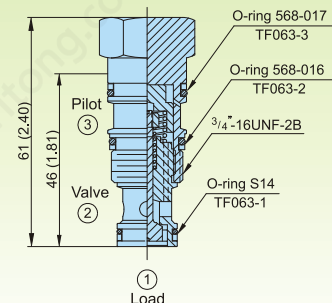
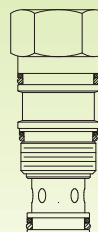
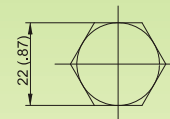



## DIMENSIONS

MILLIMETERS(INCHES)

### CPF SERIES PILOT TO OPEN CHECK VALVES

(Screw - in Cartridge Valves)

#### Ordering Code

**CPF - 063 - V - 2.0 N**

Seals: N-Buna N  
V-Viton

Cracking Pressure  
0.2 - 0.2 bar  
2.0 - 2.5 bar

Pilot Port & Internal Seals  
V - With External Pilot Port,  
No Pilot Piston Seal  
W - With External Pilot Port,  
Seal on Pilot Piston

Cavity Size

Series No. Pilot to Open Check Valves

#### Cartridge Valve Specifications

Flow rating	30 lpm (8 gpm)
Max. Pressure	315 bar (4500 psi)
Weight of Cartridge	0.12 kg
Cavity No.	C - 063 (See Cavity Details section)
Cavity Tools	CT36-D, CT36-R
Mounting	No Restrictions
Description:	Poppet Type, 4.5:1 Pilot Ratio



#### Flow-Pres. Drop Curve

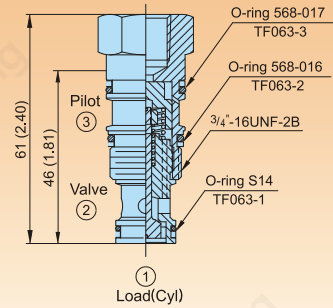
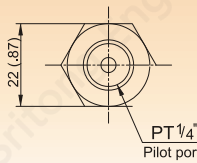
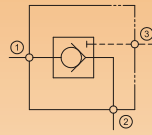
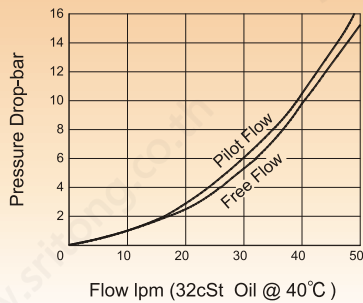

### CBC SERIES COUNTERBALANCE VALVES

(Screw - in Cartridge Valves)

#### Ordering Code

**CBC - 093 - L - 2R N**

Seals: N-Buna N  
V-Viton

Adjustment Ranges  
2R - 20 to 150 bar  
3R - 30 to 280 bar  
\* R Cracking Pres. 2.0 bar  
2S - 20 to 150 bar  
3S - 30 to 280 bar  
\* S Cracking Pres. 0.2 bar

Controls:  
L - Leakproof

Cavity Size

Series No. Counterbalance Valves

#### Cartridge Valve Specifications

Flow rating	50 lpm (13 gpm)
Max. Pressure	315 bar (4500 psi)
Weight of Cartridge	0.24 kg
Cavity No.	C - 093 (See Cavity Details section)
Cavity Tools	CT39-D, CT39-R
Mounting	No Restrictions
Description:	Poppet Type, 3:1 Pilot Ratio



#### Flow-Pres. Drop Curve

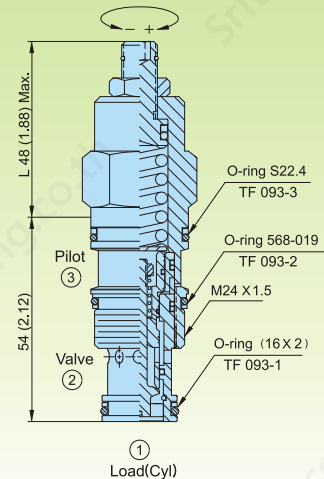
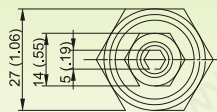
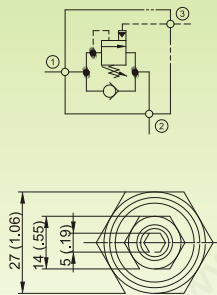
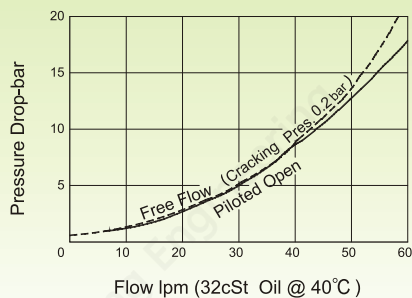

## DIMENSIONS

## MILLIMETERS(INCHES)

### CBF SERIES COUNTERBALANCE VALVES

(Screw - in Cartridge Valves)

#### Ordering Code

**CBF - 093 - L - 2R N**

Seals: N-Buna N  
V-Viton

Adjustment Ranges  
2R - 25 to 210 bar  
3R - 45 to 315 bar  
\* R Cracking Pres. 2.0 bar  
2S - 25 to 210 bar  
3S - 45 to 315 bar  
\* S Cracking Pres. 0.2 bar

Controls:

L - Leakproof

Cavity Size

Series No. Counterbalance Valves

#### Flow-Pres. Drop Curve

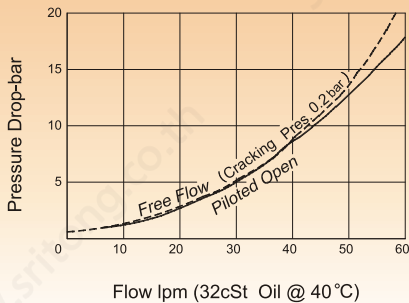

#### Cartridge Valve Specifications

Flow rating	50 lpm (13 gpm)
Max. Pressure	315 bar (4500 psi)
Weight of Cartridge	0.24 kg
Cavity No.	C - 093 (See Cavity Details section)
Cavity Tools	CT39-D, CT39-R
Mounting	No Restrictions
Description	Poppet Type, 4.5:1 Pilot Ratio

Control "L"

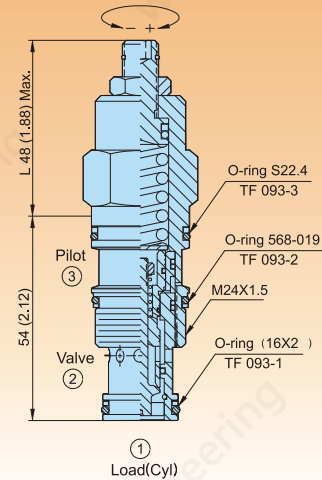
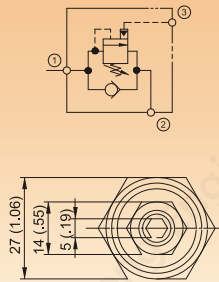

### CBJ SERIES COUNTERBALANCE VALVES

(Screw - in Cartridge Valves)

#### Ordering Code

**CBJ - 093 - L - 3R N**

Seals: N-Buna N  
V-Viton

Adjustment Ranges  
3R - 45 to 315 bar  
4R - 70 to 470 bar  
\* R Cracking Pres. 2.0 bar  
3S - 45 to 315 bar  
4S - 70 to 470 bar  
\* S Cracking Pres. 0.2 bar

Controls:

L - Leakproof

Cavity Size

Series No. Counterbalance Valves

#### Flow-Pres. Drop Curve

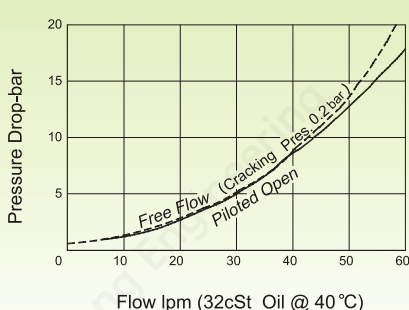

#### Cartridge Valve Specifications

Flow rating	50 lpm (13 gpm)
Max. Pressure	315 bar (4500 psi)
Weight of Cartridge	0.24 kg
Cavity No.	C - 093 (See Cavity Details section)
Cavity Tools	CT39-D, CT39-R
Mounting	No Restrictions
Description	Poppet Type, 10:1 Pilot Ratio

Control "L"

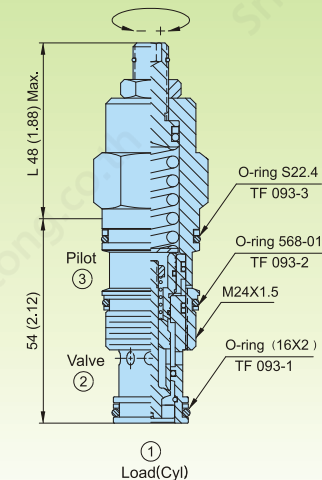
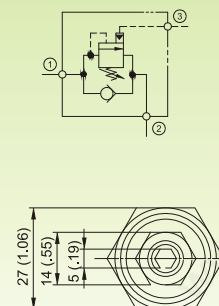



## DIMENSIONS

MILLIMETERS(INCHES)

### CPF SERIES PILOT TO OPEN CHECK VALVES

(Screw - in Cartridge Valves)

#### Ordering Code

**CPF - 093 - X - 2.0 N**

Seals: N-Buna N  
V-Viton

Cracking Pressure  
0.2 - 0.2 bar (X Type)  
2.0 - 2.5 bar (X Type)  
3.0 - 3.0 bar (S Type Only)

Internal Seals  
X - No Pilot Piston Seal  
S - Seal on Pilot Piston

Cavity Size

Series No.  
Pilot to Open Check Valves

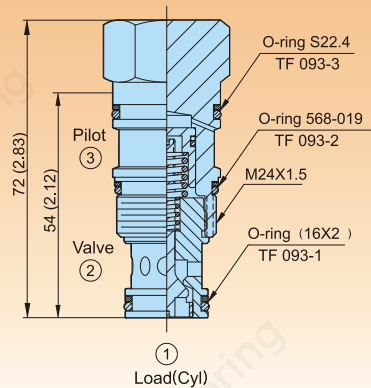
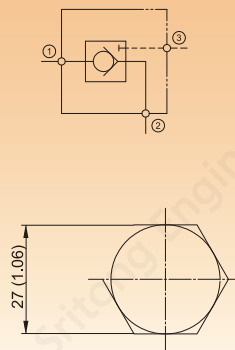
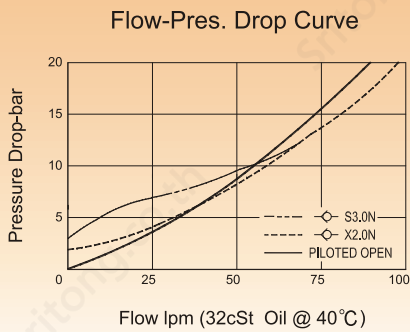

#### Cartridge Valve Specifications

Flow rating	50 lpm (13 gpm)
Max. Pressure	315 bar (4500 psi)
Weight of Cartridge	0.22 kg
Cavity No.	C - 093 (See Cavity Details section)
Cavity Tools	CT39-D, CT39-R
Mounting	No Restrictions
Description:	Poppet Type, 4.5:1 Pilot Ratio



# C

### CPF SERIES PILOT TO OPEN CHECK VALVES

(Screw - in Cartridge Valves)

#### Ordering Code

**CPF - 093 - V - 2.0 N**

Seals: N-Buna N  
V-Viton

Cracking Pressure  
0.2 - 0.2 bar  
2.0 - 2.5 bar

Pilot Port & Internal Seals  
V - With External Pilot,  
No Pilot Piston Seal  
W - With External Pilot,  
Seal on Pilot Piston

Cavity Size

Series No. Pilot to Open Check Valves

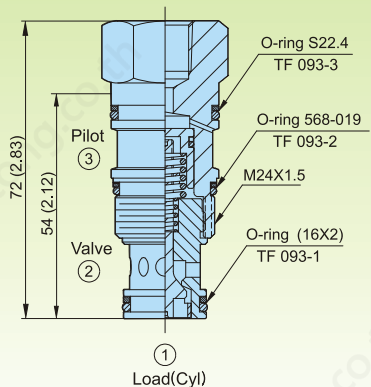
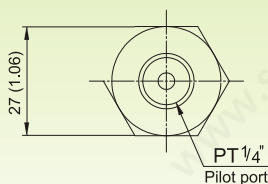
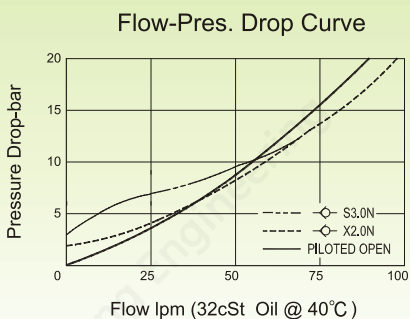

#### Cartridge Valve Specifications

Flow rating	50 lpm (13 gpm)
Max. Pressure	315 bar (4500 psi)
Weight of Cartridge	0.22 kg
Cavity No.	C - 093 (See Cavity Details section)
Cavity Tools	CT39-D, CT39-R
Mounting	No Restrictions
Description:	Poppet Type, 4.5:1 Pilot Ratio





## DIMENSIONS

## MILLIMETERS(INCHES)

### CNC SERIES FLOW CONTROL VALVES

(Screw - in Cartridge Valves)

#### Ordering Code

**CNC - 082 - L - 25 N**

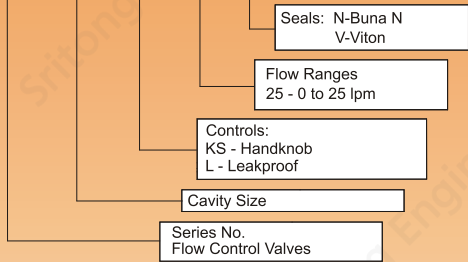

#### Cartridge Valve Specifications

Flow rating	25 lpm (6 gpm)
Max. Pressure	250 bar (3500 psi)
Weight of Cartridge	0.14 kg
Cavity No.	C - 082 (See Cavity Details section)
Cavity Tools	CT28-D, CT28-R
Mounting	No Restrictions
Description: Flow Regulator with Reverse Free Flow Check	

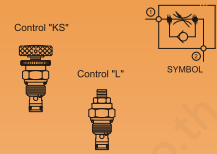

#### Flow-Pres. Drop Curve

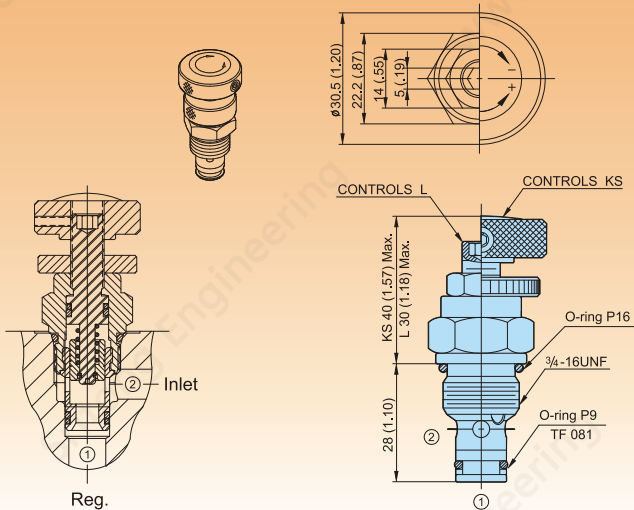
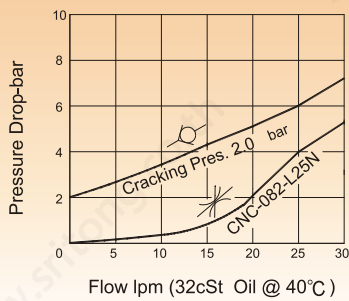

### CCN SERIES NEEDLE CHECK VALVES

(Screw - in Cartridge Valves)

#### Ordering Code

**CCN - 082 - L - 4.0 N**

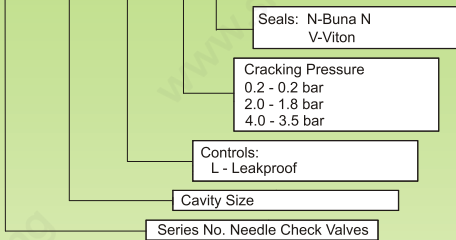

#### Cartridge Valve Specifications

Flow rating	30 lpm (8 gpm)
Max. Pressure	250 bar (3500 psi)
Weight of Cartridge	0.08 kg
Cavity No.	C - 082 (See Cavity Details section)
Cavity Tools	CT28-D, CT28-R
Mounting	No Restrictions
Description: Poppet, Direct Acting	

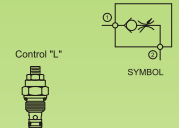

#### Flow-Pres. Drop Curve

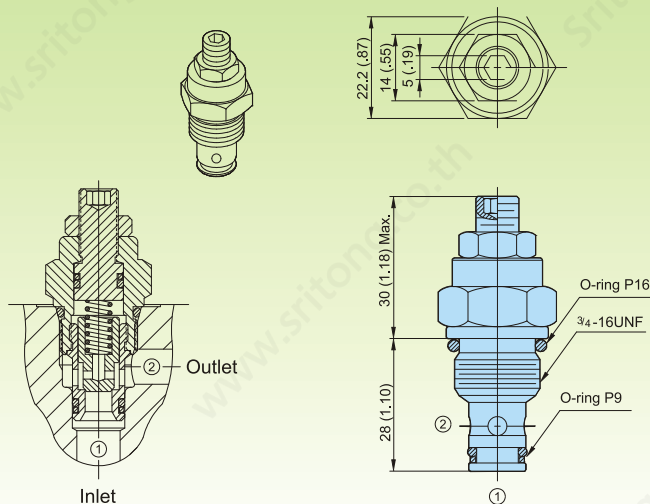
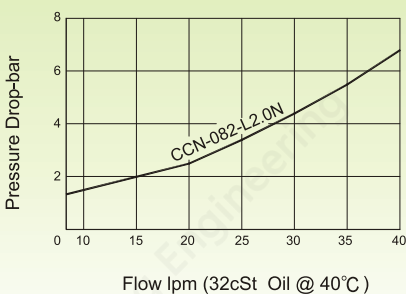

## DIMENSIONS

MILLIMETERS(INCHES)

### CNB SERIES NEEDLE VALVES

(Screw - in Cartridge Valves)

#### Ordering Code

**CNB - 082 - L - 20 N**

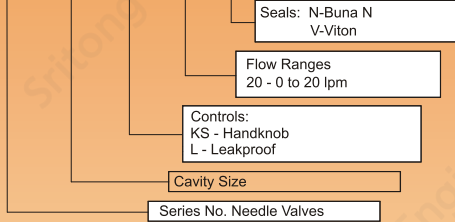

#### Cartridge Valve Specifications

Flow rating	20 lpm (5 gpm)
Max. Pressure	250 bar (3500 psi)
Weight of Cartridge	KS: 0.15kg (L: 0.09kg)
Cavity No.	C - 082 (See Cavity Details section)
Cavity Tools	CT28-D, CT28-R
Mounting	No Restrictions
Description	Fine Adjustment, Positive Shut off

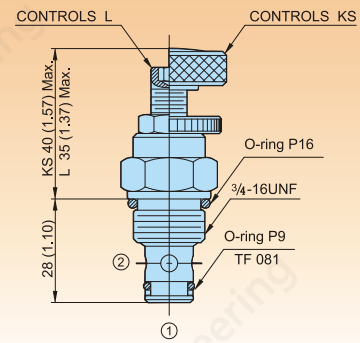
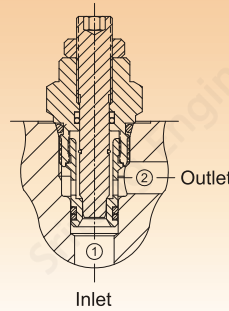
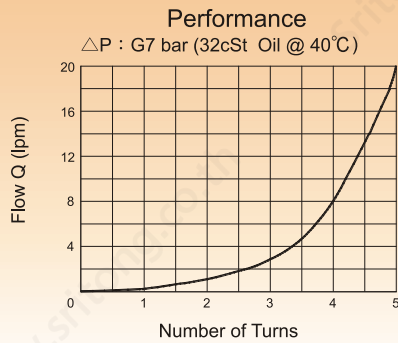
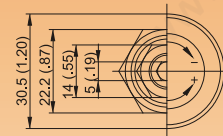
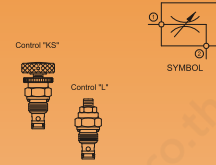

### CNV SERIES NEEDLE VALVES

(Screw - in Cartridge Valves)

#### Ordering Code

**CNV - 082 - L - 30 N**

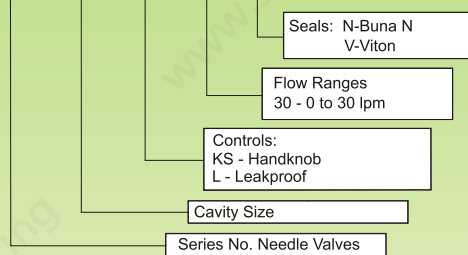

#### Cartridge Valve Specifications

Flow rating	30 lpm (8 gpm)
Max. Pressure	250 bar (3500 psi)
Weight of Cartridge	KS: 0.15kg (L: 0.09kg)
Cavity No.	C - 082 (See Cavity Details section)
Cavity Tools	CT28-D, CT28-R
Mounting	No Restrictions
Description	Direct Acting, Positive Shut off

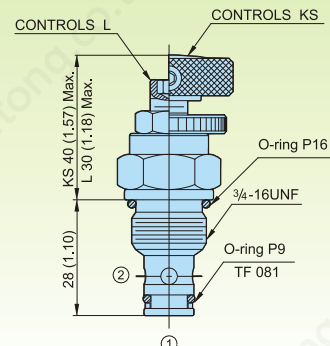
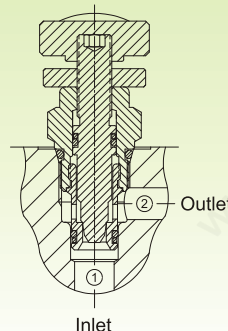
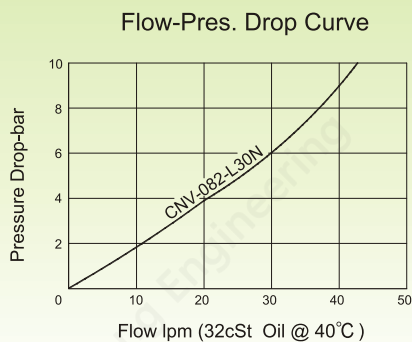
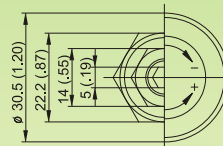
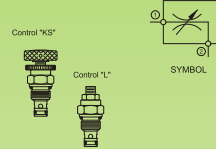

## DIMENSIONS

MILLIMETERS(INCHES)

### CNV SERIES NEEDLE VALVES

(Screw - in Cartridge Valves)

#### Ordering Code

**CNV - 102 - L - 50 N**

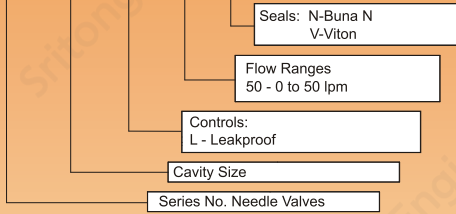

#### Cartridge Valve Specifications

Flow rating	50 lpm (13 gpm)
Max. Pressure	250 bar (3500 psi)
Weight of Cartridge	L: 0.15 kg
Cavity No.	C - 102 (See Cavity Details section)
Cavity Tools	CT20-D, CT20-R
Mounting	No Restrictions
Description	Direct Acting, Positive Shut off

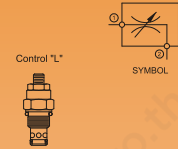

#### Flow-Pres. Drop Curve

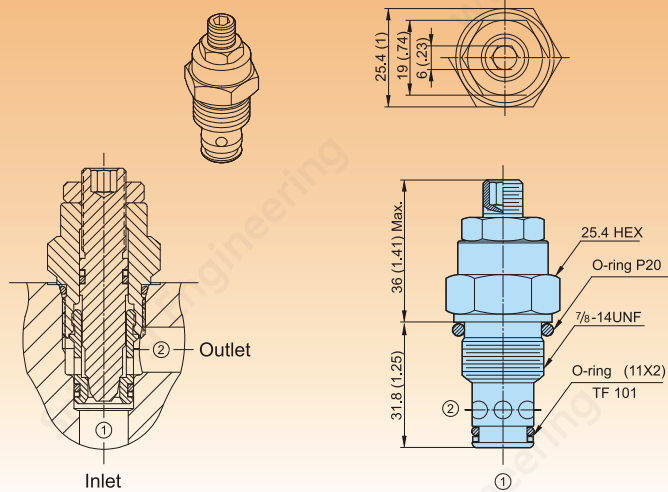
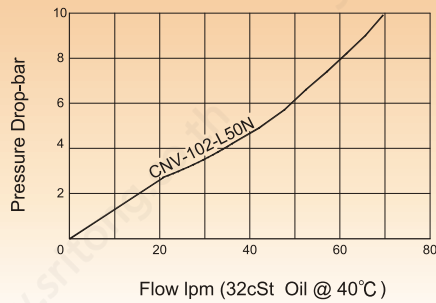

### CCN SERIES NEEDLE CHECK VALVES

(Screw - in Cartridge Valves)

#### Ordering Code

**CCN - 102 - L - 0.2 N**

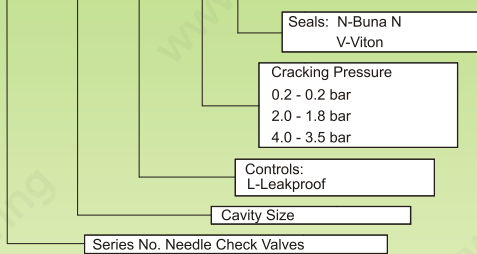

#### Cartridge Valve Specifications

Flow rating	50 lpm (13 gpm)
Max. Pressure	250 bar (3500 psi)
Weight of Cartridge	0.15 kg
Cavity No.	C - 102 (See Cavity Details section)
Cavity Tools	CT20-D, CT20-R
Mounting	No Restrictions
Description	Poppet, Direct Acting

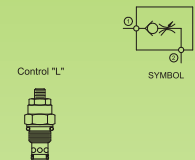

#### Flow-Pres. Drop Curve

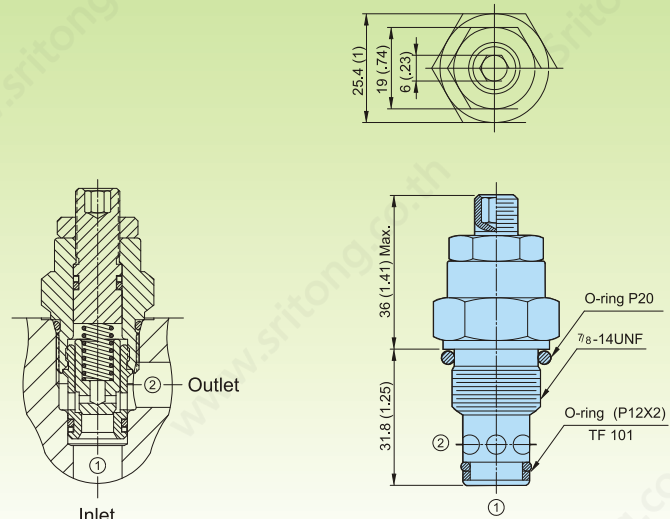
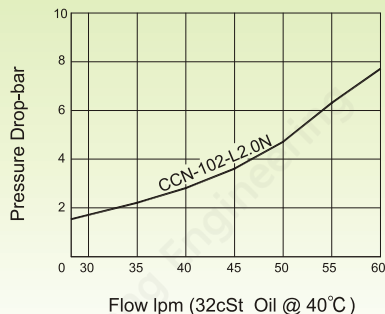



## DIMENSIONS

MILLIMETERS(INCHES)

### NEEDLE CHECK VALVES

(Screw - in Cartridge Valves)

#### Ordering Code

**CCN - 122 - L - 0.2 N**

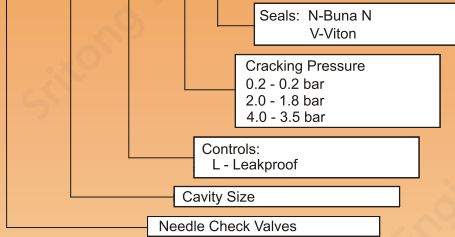

#### Cartridge Valve Specifications

Flow rating	80 lpm (21 gpm)
Max. Pressure	250 bar (3500 psi)
Weight of Cartridge	0.23 kg
Cavity No.	C - 122 (See Cavity Details section)
Cavity Tools	CT22-D, CT22-R
Mounting	No Restrictions
Description	Poppet, Direct Acting



#### Flow-Pres. Drop Curve

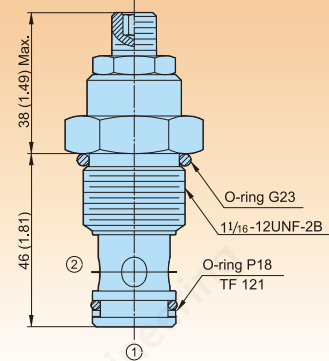
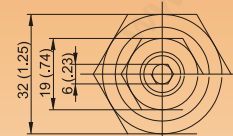
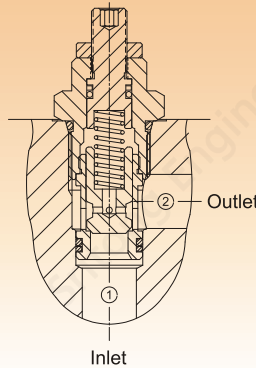
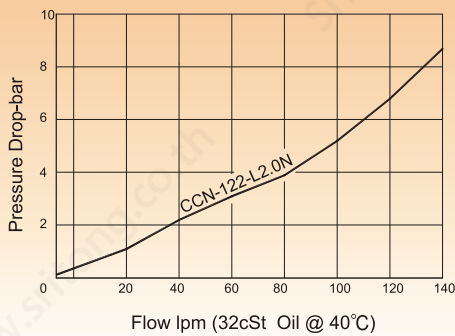

### CCV SERIES CHECK VALVES

(Screw - in Cartridge Valves)

#### Ordering Code

**CCV - 062 - X - 0.2 N**

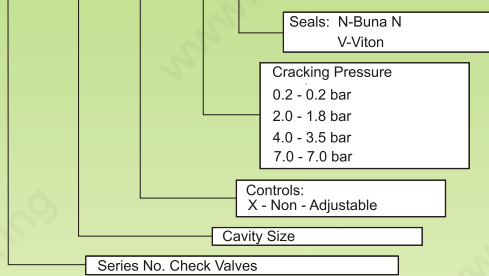

#### Cartridge Valve Specifications

Flow rating	40 lpm (10 gpm)
Max. Pressure	315 bar (4500 psi)
Weight of Cartridge	0.06 kg
Cavity No.	C - 062 (See Cavity Details section)
Cavity Tools	CTS6-D, CTS6-R
Mounting	No Restrictions
Description	Poppet Type

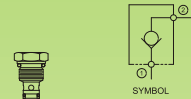

#### Flow-Pres. Drop Curve

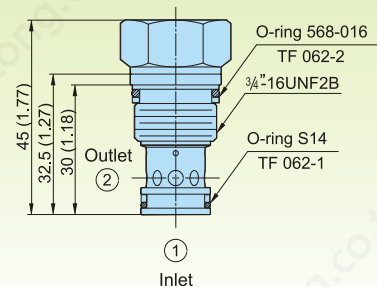
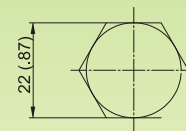
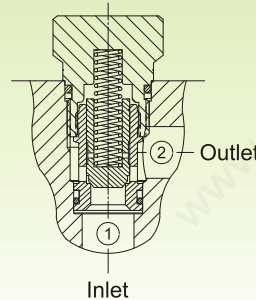
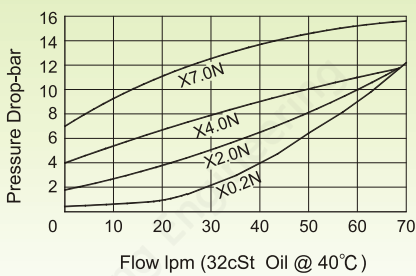

## DIMENSIONS

MILLIMETERS(INCHES)

### CCL SERIES CHECK VALVES

(Screw - in Cartridge Valves)

#### Ordering Code

**CCL - 062 - X - 0.2 N**

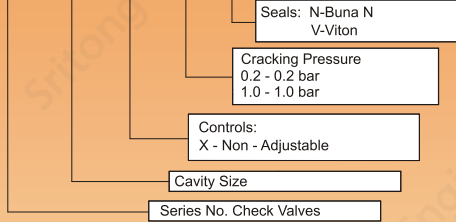

#### Cartridge Valve Specifications

Flow rating	25 lpm (6 gpm)
Max. Pressure	210 bar (3000 psi)
Weight of Cartridge	0.06 kg
Cavity No.	C - 062 (See Cavity Details section)
Cavity Tools	CTS6-D, CTS6-R
Mounting	No Restrictions
Description: Poppet Type, Free Flow from Port ② to Port ①	



#### Flow-Pres. Drop Curve

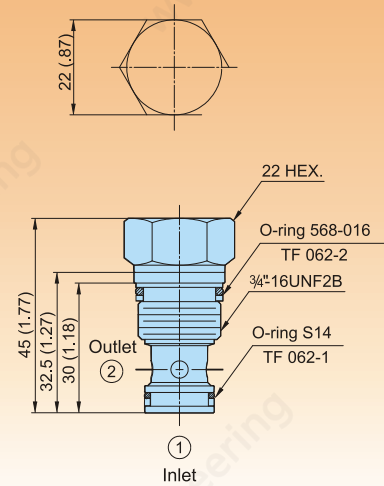
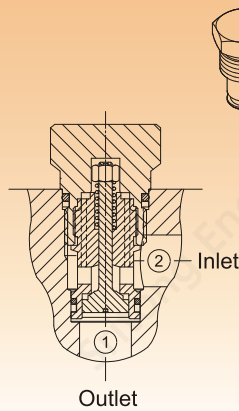
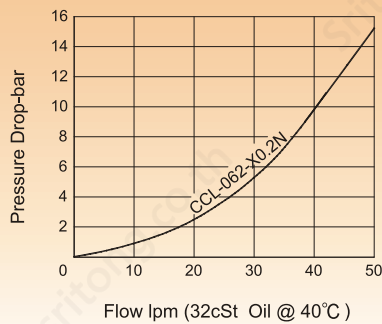

### CPO SERIES PILOT TO CLOSE CHECK VALVES

(Screw - in Cartridge Valves)

#### Ordering Code

**CPO - 063 - X - 0.2 N**

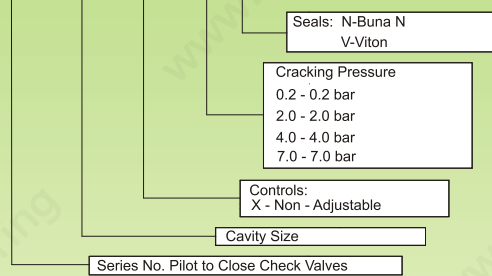

#### Cartridge Valve Specifications

Flow rating	40 lpm (10 gpm)
Max. Pressure	315 bar (4500 psi)
Weight of Cartridge	0.12 kg
Cavity No.	C - 063 (See Cavity Details section)
Cavity Tools	CT36-D, CT36-R
Mounting	No Restrictions
Description: Poppet Type, 1.96:1 Pilot Ratio	

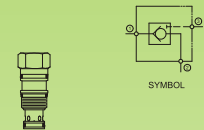

#### Flow-Pres. Drop Curve

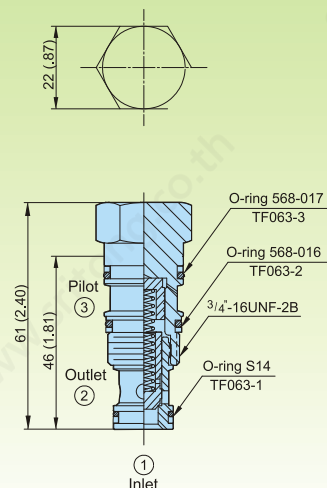
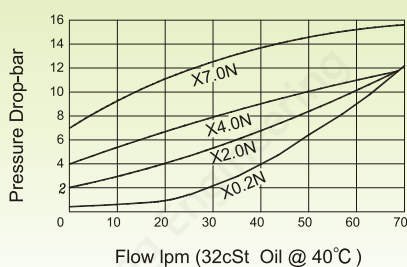



## DIMENSIONS

MILLIMETERS(INCHES)

### CAA SERIES SHUTTLE VALVES

(Screw - in Cartridge Valves)

#### Ordering Code

**CAA - 063 - XX - N**

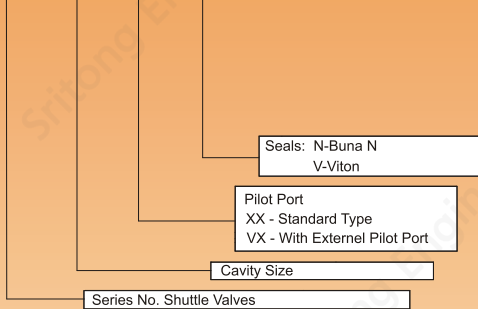

#### Cartridge Valve Specifications

Flow rating	20 lpm (5 gpm)
Max. Pressure	315 bar (4500 psi)
Weight of Cartridge	0.12 kg
Cavity No.	C - 063 (See Cavity Details section)
Cavity Tools	CT36-D, CT36-R
Mounting	No Restrictions
Description:	Ball Type

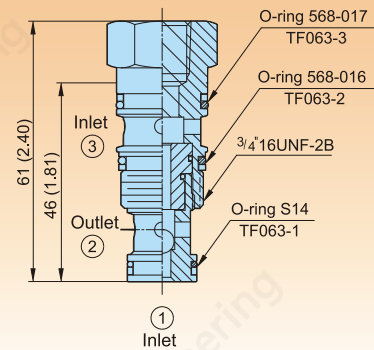
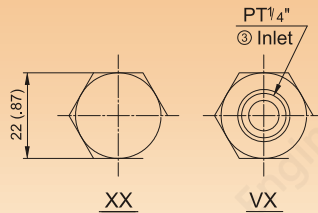
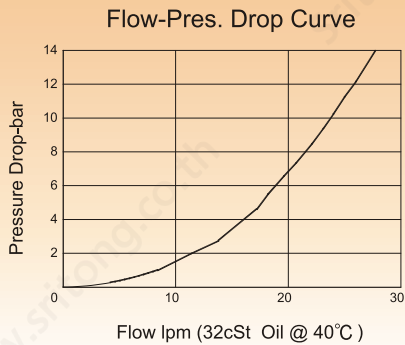
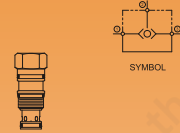

### CCV SERIES CHECK VALVES

(Screw - in Cartridge Valves)

#### Ordering Code

**CCV - 082 - X - 0.2 N**

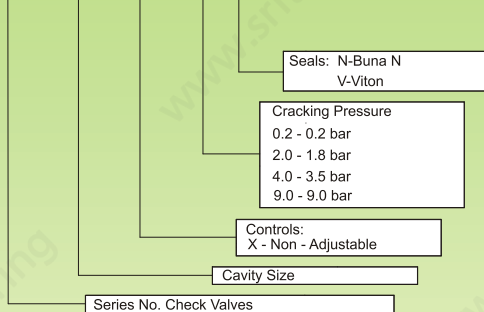

#### Cartridge Valve Specifications

Flow rating	25 lpm (6 gpm)
Max. Pressure	250 bar (3500 psi)
Weight of Cartridge	0.06 kg
Cavity No.	C - 082 (See Cavity Details section)
Cavity Tools	CT28-D, CT28-R
Mounting	No Restrictions
Description:	Poppet Type

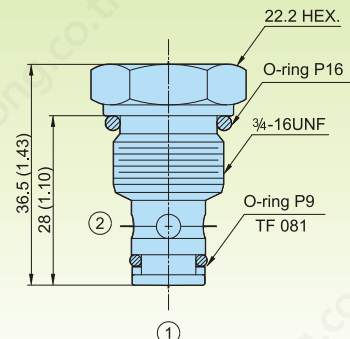
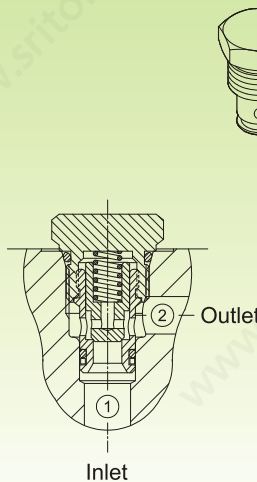
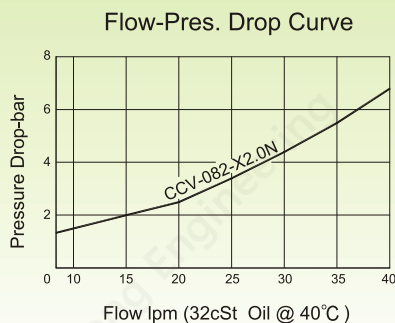
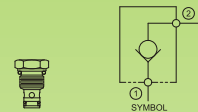

## DIMENSIONS

MILLIMETERS(INCHES)

### CCL SERIES CHECK VALVES

(Screw - in Cartridge Valves)

#### Ordering Code

**CCL - 082 - X - 0.2 N**

Seals: N-Buna N  
V-Viton

Cracking Pressure  
0.2 - 0.2 bar  
1.0 - 1.0 bar

Controls:  
X - Non - Adjustable

Cavity Size

Series No. Check Valves

#### Cartridge Valve Specifications

Flow rating	15 lpm (4 gpm)
Max. Pressure	210 bar (3000 psi)
Weight of Cartridge	0.06 kg
Cavity No.	C - 082 (See Cavity Details section)
Cavity Tools	CT28-D, CT28-R
Mounting	No Restrictions
Description	Poppet Type, Free Flow from Port ② to Port ①

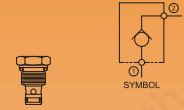

Flow-Pres. Drop Curve

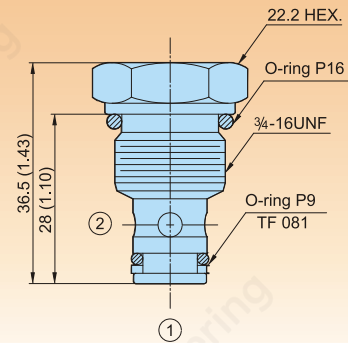
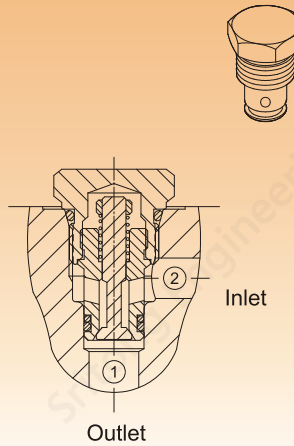
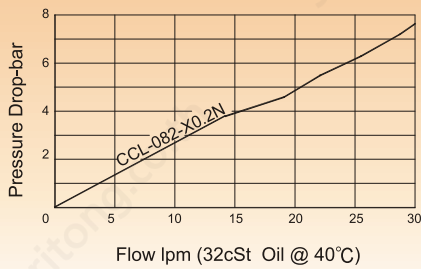

### CPO SERIES PILOT TO CLOSE CHECK VALVES

(Screw - in Cartridge Valves)

#### Ordering Code

**CPO - 093 - X - 0.2 N**

Seals: N-Buna N  
V-Viton

Cracking Pressure  
0.2 - 0.2 bar  
2.0 - 2.0 bar  
7.0 - 7.0 bar

Controls:  
X - Non - Adjustable

Cavity Size

Series No. Pilot to Close Check Valves

#### Cartridge Valve Specifications

Flow rating	60 lpm (16 gpm)
Max. Pressure	315 bar (4500 psi)
Weight of Cartridge	0.22 kg
Cavity No.	C - 093 (See Cavity Details section)
Cavity Tools	CT39-D, CT39-R
Mounting	No Restrictions
Description	Poppet Type, 1.96:1 Pilot Ratio

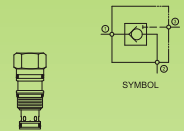

Flow-Pres. Drop Curve

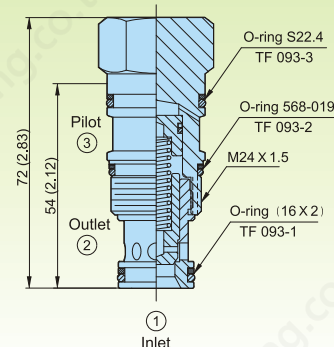
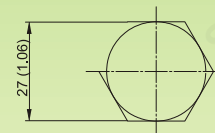
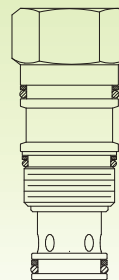
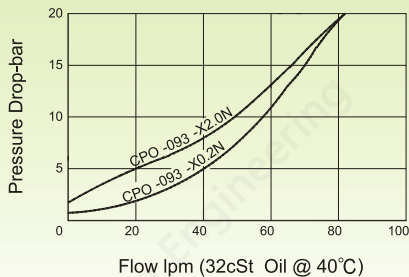



## DIMENSIONS

MILLIMETERS(INCHES)

### CCV SERIES CHECK VALVES

(Screw - in Cartridge Valves)

#### Ordering Code

**CCV - 102 - X - 0.2 N**

Seals: N-Buna N  
V-Viton

Cracking Pressure  
0.2 - 0.2 bar  
2.0 - 1.8 bar  
4.0 - 3.5 bar

Controls:  
X - Non - Adjustable

Cavity Size

Series No. Check Valves

#### Cartridge Valve Specifications

Flow rating	45 lpm (12 gpm)
Max. Pressure	250 bar (3500 psi)
Weight of Cartridge	0.08 kg
Cavity No.	C - 102 (See Cavity Details section)
Cavity Tools	CT20-D, CT20-R
Mounting	No Restrictions
Description	Poppet Type



#### Flow-Pres. Drop Curve

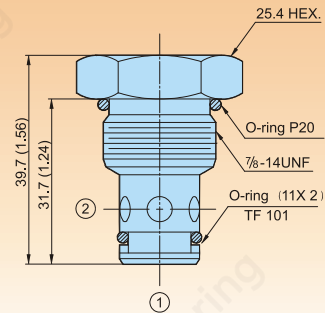
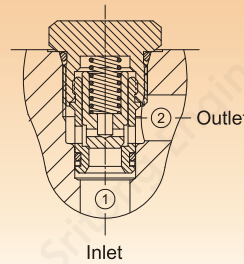
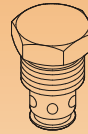
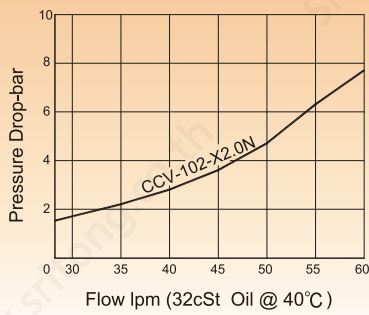

### CCV SERIES CHECK VALVES

(Screw - in Cartridge Valves)

#### Ordering Code

**CCV - 122 - X - 0.2 N**

Seals: N-Buna N  
V-Viton

Cracking Pressure  
0.2 - 0.2 bar  
2.0 - 1.8 bar  
4.0 - 3.5 bar

Controls:  
X - Non - Adjustable

Cavity Size

Series No. Check Valves

#### Cartridge Valve Specifications

Flow rating	80 lpm (21 gpm)
Max. Pressure	250 bar (3500 psi)
Weight of Cartridge	0.16 kg
Cavity No.	C - 122 (See Cavity Details section)
Cavity Tools	CT22-D, CT22-R
Mounting	No Restrictions
Description	Poppet Type



#### Flow-Pres. Drop Curve

